



Option Modules

Modbus RTU Option

HA501839U001 Issue 4
Technical Manual

aerospace
climate control
electromechanical
filtration
fluid & gas handling
hydraulics
pneumatics
process control
sealing & shielding



ENGINEERING YOUR SUCCESS



AC30 Modbus RTU Option

Technical Manual HA501839U001 Issue 4

Copyright 2016 Parker Hannifin Manufacturing Limited

All rights strictly reserved. No part of this document may be stored in a retrieval system, or transmitted in any form or by any means to persons not employed by a Parker company without written permission from Parker Hannifin Ltd. Although every effort has been taken to ensure the accuracy of this document it may be necessary, without notice, to make amendments or correct omissions. Parker cannot accept responsibility for damage, injury, or expenses resulting therefrom.

Parker Hannifin Manufacturing Limited is referred to throughout this document as Parker.

WARRANTY

The general terms and conditions of sale of goods and/or services of Parker Hannifin Europe Sàrl, Luxembourg, Switzerland Branch, Ettoy, apply to this product unless otherwise agreed. The terms and conditions are available on our website www.parker.com/termsandconditions/switzerland.

FAILURE OR IMPROPER SELECTION OR IMPROPER USE OF THE PRODUCTS DESCRIBED HEREIN OR RELATED ITEMS CAN CAUSE DEATH, PERSONAL INJURY AND PROPERTY DAMAGE.

This document and other information from Parker-Hannifin Corporation, its subsidiaries and authorized distributors provide product or system options for further investigation by users having technical expertise.

The user, through its own analysis and testing, is solely responsible for making the final selection of the system and components and assuring that all performance, endurance, maintenance, safety and warning requirements of the application are met. The user must analyze all aspects of the application, follow applicable industry standards, and follow the information concerning the product in the current product catalog and in any other materials provided from Parker or its subsidiaries or authorized distributors.

To the extent that Parker or its subsidiaries or authorized distributors provide component or system options based upon data or specifications provided by the user, the user is responsible for determining that such data and specifications are suitable and sufficient for all applications and reasonably foreseeable uses of the components or systems.

The above disclaimer is being specifically brought to the user's attention and is in addition to and not in substitution to the Exclusions and Limitations on Liability which are set out in the terms and conditions of sale.

Safety Information



Requirements

IMPORTANT: Please read this information *BEFORE* installing the equipment.

Intended Users

This manual is to be made available to all persons who are required to install, configure or service equipment described herein, or any other associated operation.

The information given is intended to highlight safety issues, EMC considerations, and to enable the user to obtain maximum benefit from the equipment.

Complete the following table for future reference detailing how the unit is to be installed and used.

INSTALLATION DETAILS	
Model Number <i>(see product label)</i>	
Where installed <i>(for your own information)</i>	

Application Area

The equipment described is intended for industrial motor speed control utilising AC induction or AC synchronous machines.

Personnel

Installation, operation and maintenance of the equipment should be carried out by competent personnel. A competent person is someone who is technically qualified and familiar with all safety information and established safety practices; with the installation process, operation and maintenance of this equipment; and with all the hazards involved.

Product Warnings

 DANGER Risk of electric shock	 WARNING Hot surfaces	 Caution Refer to documentation	 Earth/Ground Protective Conductor Terminal
---	--	--	--

CAUTION!

APPLICATION RISK

- The specifications, processes and circuitry described herein are for guidance only and may need to be adapted to the user's specific application. We cannot guarantee the suitability of the equipment described in this Manual for individual applications.

RISK ASSESSMENT

Under fault conditions, power loss or unintended operating conditions, the drive may not operate as intended. In particular:

- Stored energy might not discharge to safe levels as quickly as suggested, and can still be present even though the drive appears to be switched off
- The motor's direction of rotation might not be controlled
- The motor speed might not be controlled
- The motor might be energised

A drive is a component within a drive system that may influence its operation or effects under a fault condition. Consideration must be given to:

- Stored energy
- Supply disconnects
- Sequencing logic
- Unintended operation

Safety Information



DANGER! - Ignoring the following may result in injury

1. This equipment can endanger life by exposure to rotating machinery and high voltages.
2. The equipment must be permanently earthed due to the high earth leakage current, and the drive motor must be connected to an appropriate safety earth.
3. Ensure all incoming supplies are isolated before working on the equipment. Be aware that there may be more than one supply connection to the drive.
4. There may still be dangerous voltages present at power terminals (motor output, supply input phases, DC bus and the brake, where fitted) when the motor is at standstill or is stopped.
5. For measurements use only a meter to IEC 61010 (CAT III or higher). Always begin using the highest range. CAT I and CAT II meters must not be used on this product.
6. Allow at least 5 minutes for the drive's capacitors to discharge to safe voltage levels (<50V). Use the specified meter capable of measuring up to 1000V dc & ac rms to confirm that less than 50V is present between all power terminals and between power terminals and earth.
7. Unless otherwise stated, this product must NOT be dismantled. In the event of a fault the drive must be returned. Refer to "Routine Maintenance and Repair".

WARNING! - Ignoring the following may result in injury or damage to equipment

SAFETY

Where there is conflict between EMC and Safety requirements, personnel safety shall always take precedence.

- Never perform high voltage resistance checks on the wiring without first disconnecting the drive from the circuit being tested.
- Whilst ensuring ventilation is sufficient, provide guarding and /or additional safety systems to prevent injury or damage to equipment.
- When replacing a drive in an application and before returning to use, it is essential that all user defined parameters for the product's operation are correctly installed.
- All control and signal terminals are SELV, i.e. protected by double insulation. Ensure all external wiring is rated for the highest system voltage.
- Thermal sensors contained within the motor must have at least basic insulation.
- All exposed metalwork in the Inverter is protected by basic insulation and bonded to a safety earth.
- RCDs are not recommended for use with this product but, where their use is mandatory, only Type B RCDs should be used.

EMC

- In a domestic environment this product may cause radio interference in which case supplementary mitigation measures may be required.
- This equipment contains electrostatic discharge (ESD) sensitive parts. Observe static control precautions when handling, installing and servicing this product.
- This is a product of the restricted sales distribution class according to IEC 61800-3. It is designated as "professional equipment" as defined in EN61000-3-2. Permission of the supply authority shall be obtained before connection to the low voltage supply.

Disposal

Waste Electrical and Electronic Equipment (WEEE)



Waste Electrical and Electronic Equipment - must not be disposed of with domestic waste.

It must be separately collected according to local legislation and applicable laws.

Parker Hannifin Company, together with local distributors and in accordance with EU directive 2002/96/EC, undertakes to withdraw and dispose of its products, fully respecting environmental considerations.

For more information about how to recycle your Parker supplied waste equipment, please contact your local Parker Service Centre.

Packaging

During transport our products are protected by suitable packaging. This is entirely environmentally compatible and should be taken for central disposal as secondary raw material.

Contents.....	Page No.
AC30 Modbus RTU Option	1
Introduction	1
Features	1
The Product Code	1
Installation.....	2
Connecting to the Modbus RTU Network	4
RS232 Connection.....	5
RS485 Connection.....	5
LEDs.....	6
Communication (COM) Mode LED.....	6
Device Status (DS) LED.....	6
Configuration.....	7
Device Address.....	7
Baud Rate.....	7
Parity and Stop Bits	7
Process Active Timeout	7
Word Order.....	7
Process Data	7
Modbus Register Mapping	9
Modbus Mapped Communication Settings	10
Supported Modbus Functions	10
Example Configuration	12
Configuration Summary	12
Example Using TS8000 HMI	13
Configuring the AC30.....	20
Acyclic Data Exchange.....	22
Overview.....	22
Arrays	22
Strings	22
Example Acyclic String Access	23
Lost Communications Trip.....	25
Supervised Parameter	25
Comms Break Trip.....	25
Diagnostic Event	26
Parameters	27
Configuration Parameters	27
Runtime Parameters	30
Diagnostic Parameters.....	31
Troubleshooting	36
Hardware Mismatch.....	36

Invalid Configuration	36
Modbus Exceptions.....	36
Register Writing	36
Appendix A – Array Parameter Numbers.....	37
Array Example	37
Appendix B – String Parameter Numbers.....	38
String Example	38
String Array Example.....	39
Appendix C – Data Types	40

AC30 MODBUS RTU OPTION

Introduction

Features

- Modbus RTU
- Up to 115200bits/s Baud rate
- Galvanically isolated bus via DB9F female connector
- Communication and Device Status LEDs
- Up to 256 bytes of process I/O data in each direction
- Acyclic access of parameters
- Serial communications over RS485 or RS232

The Product Code

The product code for the Modbus RTU option is:

7003-RS-00

Installation

1. Remove the Graphical Keypad (GKP) by pulling from the top down, and remove.

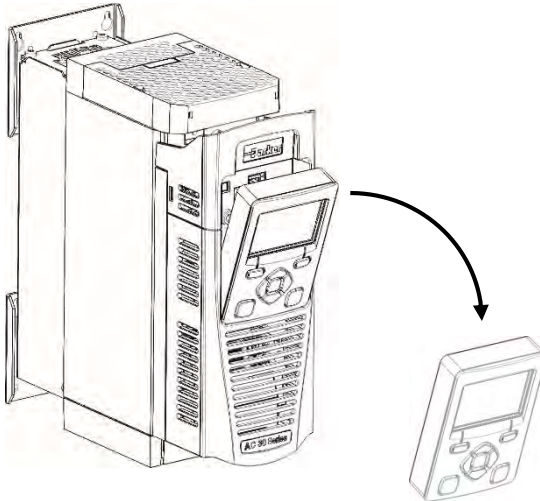

2. After removing the screw slide the control module lower cover down slightly and then remove.

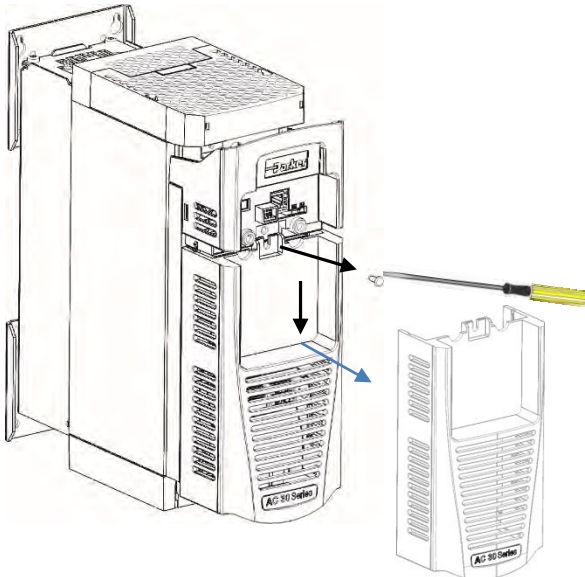

3. Click the Option into place and tighten the retaining screw, as shown.

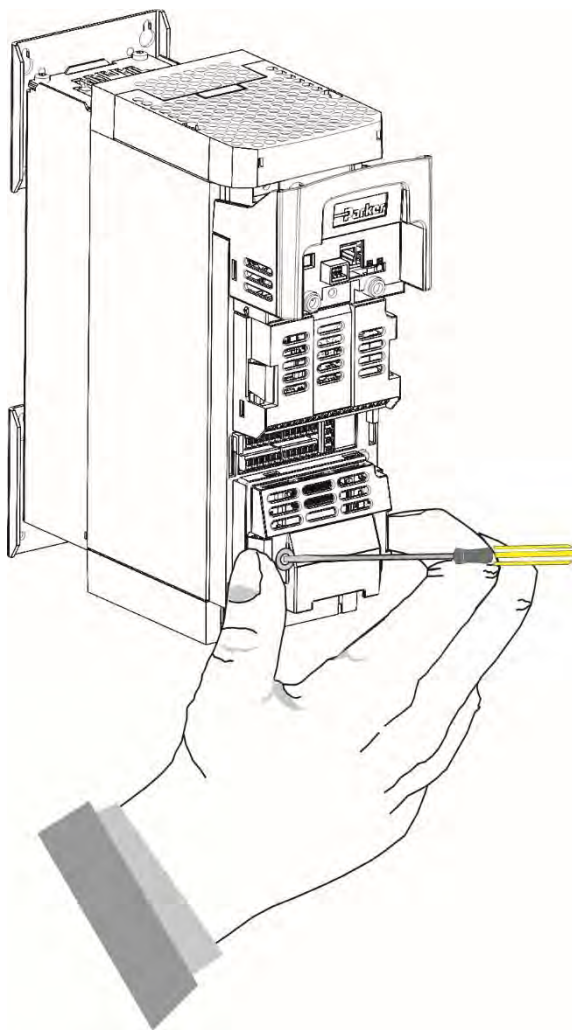

4. Slide and click back the control module lower cover, tighten the retaining screw and slot back the GKP.

Connecting to the Modbus RTU Network

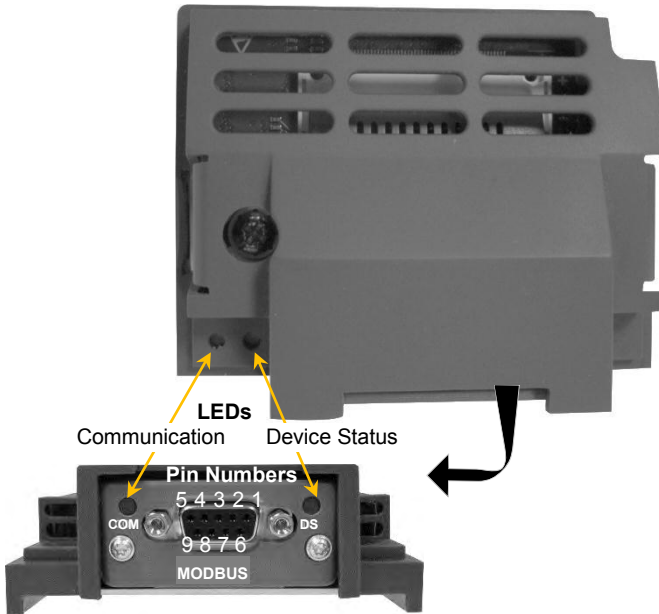

Pin	Signal	Description
1	GND	Bus polarisation, ground (isolated)
2	5V	Bus polarisation, +5V DC (isolated)
3	PMC	Connect to pin #2 for RS232 operation. Leave unconnected for RS485 operation.
4	-	
5	B-Line	RS485 B-Line
6	-	
7	Rx	RS232 Data Receive
8	Tx	RS232 Data Transmit
9	A-Line	RS485 A-Line
Housing	Cable Shield	Connected to protective earth via a filter

RS232 Connection

Connect pin #2 to pin #3.

Use pins #1, #7, #8 (GND, Rx, Tx)

Suitable for short connections <3m only.

Wiring Diagram Example

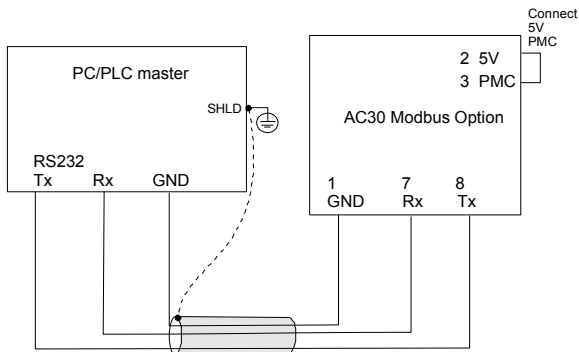

RS485 Connection

Use pins #1, #2, #5, #9 (GND, 5V, B-Line, A-Line)

Wiring Diagram Example

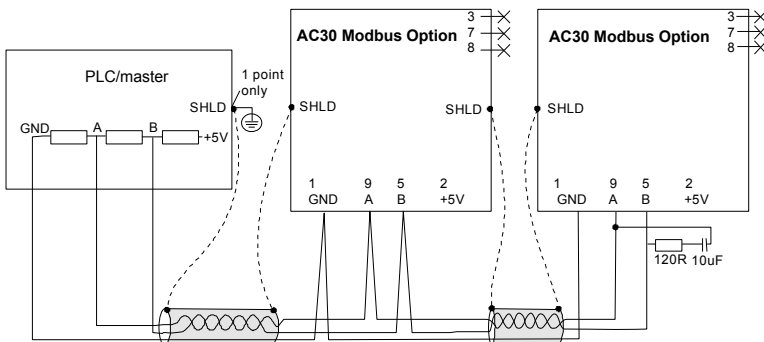

Cable: Use of CAT5E STP or FTP screened cable is recommended.

Termination and Biasing

The illustrated example assumes the Master/PLC has a terminating and biasing network built in.

Both ends of the network need terminating. 120Ω 1/4W in series with a 10nF (10V min) cap is recommended where an AC30 is at the end of the network. For other devices, check the manual to see if it has internal or switchable terminators.

The network also needs to be biased. Typically the Master/PLC will do this. If it does not, use the combined biasing and terminating scheme at one end of the network:

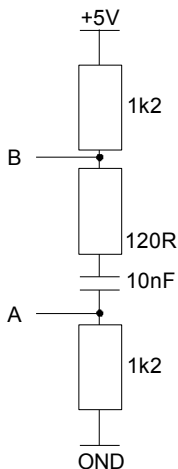

LEDs

Communication (COM) Mode LED

State	Indication
Off	No power / No traffic
Green	Frame reception or transmission
Red	A fatal error has occurred

Device Status (DS) LED

State	Indication
Off	No power or not initialised
Green	Module initialised
Red	Internal error
Red, single flash	Communication fault or configuration error. Case 1: Invalid configuration settings Case 2: Settings changed during runtime
Red, double flash	Dagnostic available.

Configuration

The option requires configuration of the slave device address, the baud rate, parity and stop bits, word order and mapping of the process data. Optionally, a process active timeout may be set. Note that some communication parameters only become active after the AC30 leaves the configuration state.

The **0044 Comms Required** parameter must be set to **MODBUS RTU**.

Device Address

The **0229 Modbus Device Address** parameter must be set to the required address for the slave. The range is the 1 - 247.

Baud Rate

The **0230 Modbus RTU Baud Rate** parameter must be set to the required baud rate for the network. A Baud rate of up to 115200 bits/s may be chosen.

Parity and Stop Bits

The **0231 Parity and Stop Bits** parameter must be set to match of the network.

Process Active Timeout

The **0233 Modbus RTU Timeout** parameter specifies how long the module shall stay in the PROCESS ACTIVE state after receiving a Modbus request.

If this is set to zero, then the module will remain in the PROCESS ACTIVE state after receiving the first Modbus request.

Word Order

The **0232 High Word First RTU** parameter specifies the network word order of 32-bit parameters. If set TRUE then the high word (most significant word) will be sent first.

Process Data

Although Modbus is acyclic by nature, the communication option allows for process data exchange. This allows a selection of parameters to be grouped together for fast I/O data exchange.

The cyclic I/O data is configured by using the read and write process data mapping tables in the AC30. These tables are two parameter arrays in which AC30 parameter numbers may be added.

String-type parameters may not be mapped.

Read Mapping

The read process data represents cyclic data sent from the master to the AC30. Only writable AC30 parameters, that are not configuration parameters, may be added to the read process data.

When the Modbus option first becomes operational, the read process data area will be pre-loaded once with data by reading the associated mapped AC30 parameters values.

Write Mapping

The write process data represents cyclic data sent from the AC30 to the PLC.

Mapping Arrays

Parameter arrays may be added into the process data, however this could lead to large amounts of data being passed across the communications. An alternative is to only reference the element(s) of the array required. This is possible as each element of a parameter array has its own parameter number. See the [Appendix A – Array Parameter Numbers](#)

Default Mapping

The process data mapping will contain a factory default mapping. The default mapping may be overwritten if required.

Process Data Exchange

Process data exchange will occur when a connection is established. The module will enter the PROCESS ACTIVE state on the first received Modbus request (including acyclic access). It will stay in this state unless a timeout occurs (if specified).

However, the read process data will only update the mapped parameters when in the PROCESS ACTIVE mode.

On a transition into the PROCESS ACTIVE state all read process mapped parameters will be updated.

When in the PROCESS ACTIVE state the read process mapped parameters will all update only when a change in the read process data occurs.

Modbus Register Mapping

The Process Data is mapped to Modbus registers. The read process data is mapped to the Holding Registers, Input Registers and Coils. The write process data is mapped to the Input Registers and Discrete Inputs. The mapping is summarised below.

Read Process Data Mapping	
Range	
00001 - 00256	4x Holding Registers
00001 - 04096	0x Coils

Write Process Data Mapping	
Range	
00257 – 00512	4x Holding Registers
00001 - 00256	3x Input Registers
00001 - 04096	1x Discrete Inputs

Each mapped AC30 parameters will map to at least one register. A parameter having a data size of 1 byte will map to the low byte of a Modbus register. The unused byte, if read, will return zero. Writing to it will have no effect. The data size of the AC30 parameter types is given in [Appendix C – Data Types](#).

Multi-element AC30 parameter (arrays), however, will be packed into the register mapping. An example mapping is shown below, mixing single-element and multi-element parameters.

Process Data Mapping		Modbus Register Mapping				
Parameter	Data Type	Register	High Byte	Low Byte		
1	USINT	00001		USINT		
2	SINT	00002		SINT		
3	INT	00003	INT			
4	BOOL	00004				
					b 0	
5	DINT	00005	DINT			
		00006				
6	BOOL[3]	00007		b 2	b 1	b 0
7	SINT[3]	00008	SINT[1]	SINT[0]		
		00009		SINT[3]		

The process data may also be accessed on a bit by bit basis (Coils and Discrete Inputs). For example, reading Discrete Inputs 00001 to 00016 will return the same data as reading Input Register 00001.

Modbus Mapped Communication Settings

Communications settings are also mapped onto the Holding Registers. Some of these settings will have no effect when modified as these will be overwritten by the AC30 when the option starts.

The mapping is summarised below.

Holding Register		
Register	Contents	Comment
00513	Node Address	Do not modify
00514	Communication Settings	Do not modify
00515	RTU/ASCII Mode	Do not modify
00516	Process Active Timeout	Process Active Timeout in milliseconds
00517	Enter/Exit Idle Mode	0: Not idle >0 Idle - the Modbus option will change to the IDLE state.

Supported Modbus Functions

The following Modbus functions are supported on the AC30 option.

Function #	Modbus Function
1	Read Coils
2	Read Discrete Inputs
3	Read Holding Registers
4	Read Input Registers
5	Write Single Coil
6	Write Single Register
8	Diagnostics
15	Write Multiple Coils
16	Write Multiple Registers
17	Report Slave ID (<i>not supported</i>)
23	Read/Write Multiple Registers
43	Read Device Identification (Subcode 14)
68	Exchange Process Data
69	<i>Reserved</i>

Exchange Process Data (Function 68)

The Exchange Process Data uses a user-defined function code 68. This can be used for efficient process data exchange.

The 'Process Data Read' and 'Process Data Write' fields can be up to 252 bytes long.

Request format:

Addr	68	Process Data Read	CRC
------	----	-------------------	-----

Response format:

Addr	68	Process Data Write	CRC
------	----	--------------------	-----

Example Configuration

Configuration Summary

Communications Settings	
Device Address	5
Baud Rate	115200 bits/s
Parity	Even
Stop Bits	1
Word Order	High word first
Process Active Timeout	1000 ms

Read Process Mapping Table		Data Type	Bytes	Holding Register
000	0627 Comms Control Word	WORD	2	00001
001	0681 Comms Reference	REAL	4	00002 – 00003
002	000			
003	000			

Write Process Mapping Table		Data Type	Bytes	Input Register
000	0661 Status Word	WORD	2	00001
001	0395 Actual Speed Percent	REAL	4	00002 – 00003
002	000			
003	000			

Example Using TS8000 HMI

Prior knowledge of the TS8000 HMI and DSI8000 Software is assumed.

1. Create a new project.

Start the DSI8000 software and click on File and New.

2. Setup the Port Communication Settings.

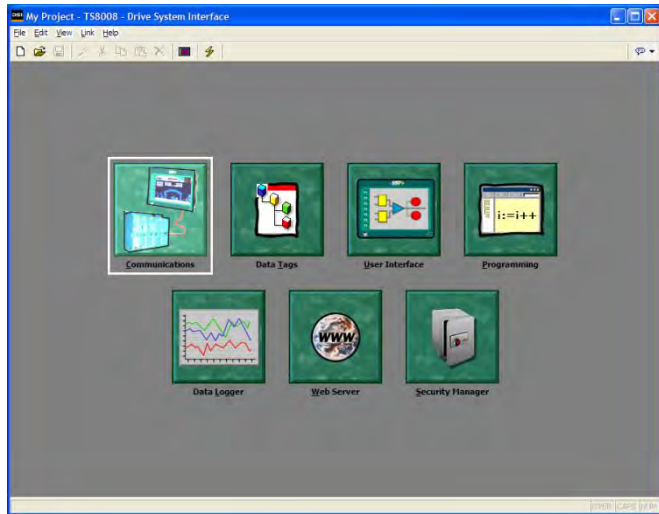

Double-click on the **Communications** tab. The RS232 port or the RS485 port may be used. In this example the RS232 port will be used.

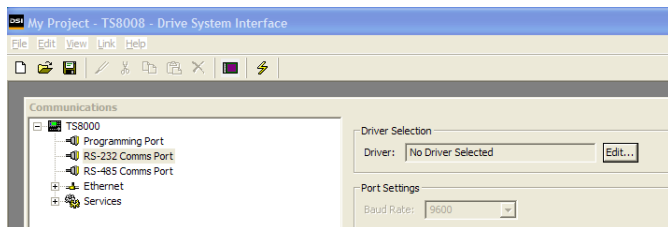

Under **TS8000**, Highlight the **RS-232 Comms Port**. Under **Driver Selection** click on **Edit...**

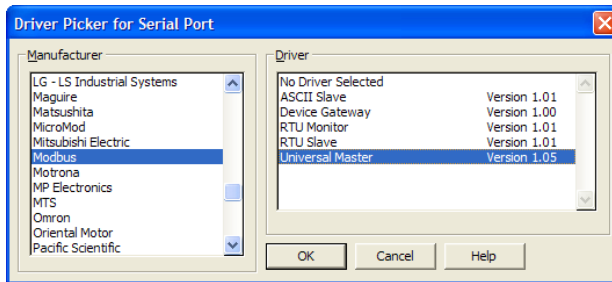

Under **Manufacturer** select **Modbus** and under **Driver** select **Universal Master**, and click OK.

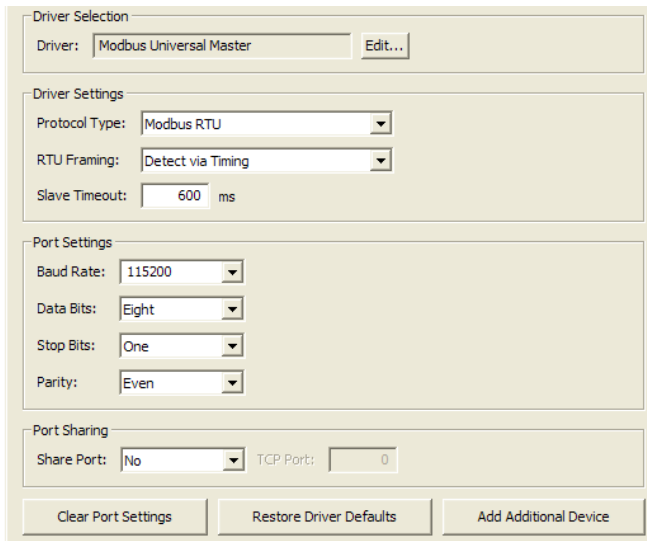

Change the communication settings as required. The **Slave Timeout** should be set long enough to allow a response frame from the slave. This will depend on the Baud rate used.

Next click on **PLC1** under **RS-232 Comms Port - Modbus Master**.

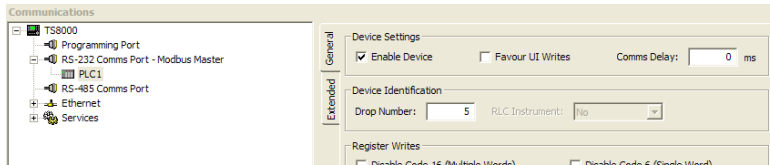

On the **General** tab set the device address under **Drop Number**. Also make sure the device is enabled.

On the **Extended** tab set the **Ping Holding Register**. This will be used by the TS8000 to detect the slave device by a read request of this register. Any valid register may be used. By default this is set to register 1.

After completing the communications setup close the Communications window.

3. Create the Data Tags

Double-click on the **Data Tags** tab.



Under **Create New Variable** click on **Integer**, then **Real**, then **Integer**, then **Real**. This will create four new parameters to represent the four parameters mapped to the process data:

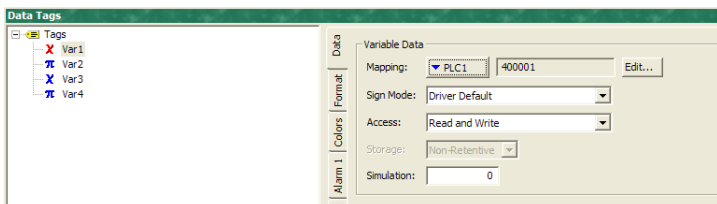

To configure tag **Var1**, highlight the tag. On the **Data** tab under mapping select **PLC1**.

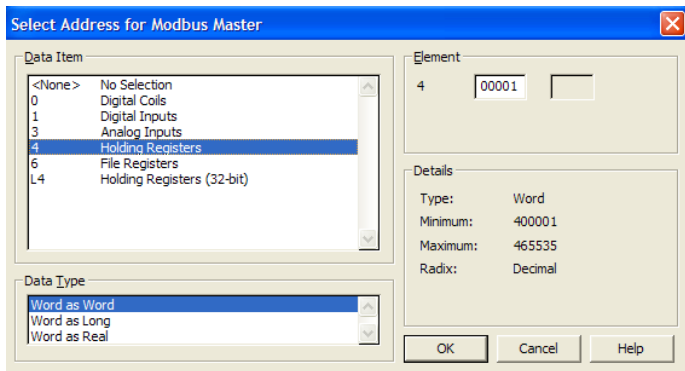

In the popup window set:
Data Item as Holding Registers
Data Type as Word as Word
Element as 00001

Click OK.

Still on the **Data** tab, make sure **Access** is set to **Read and Write**.

Click on the **Format** tag.

The screenshot shows a configuration window with a sidebar on the left containing tabs: Data, Format, Colors, Alarm 1, Alarm 2, Triggers, Security, and Comment. The 'Format' tab is active. The 'Data Label' section has a 'Label Text' field with 'Comms Control Word' and a 'Translate...' button. The 'Data Limits' section has 'Minimum Value' and 'Maximum Value' both set to 'General' and 'As Per Format', each with an 'Edit...' button. The 'Data Format' section includes: 'Number Base' set to 'Hexadecimal', 'Sign Mode' set to 'Unsigned', 'Digits Before DP' set to 4, 'Digits After DP' set to 0, 'Leading Zeros' set to 'Yes', and 'Group Digits' set to 'No'. There are 'Prefix' and 'Suffix' fields, both set to 'None', each with a 'Translate...' button. At the bottom, an 'Examples' section shows 'Positive shown as "ABCD"' and 'Negative shown as "ABCD"'. The window has a light beige background and a standard Windows-style border.

The **Label Text** may be changed from **Var1** if required. Set the **Data Format** to **Hexadecimal**.

Configure the remaining tags in a similar way as summarised below:

TS8000	Tag	Var1	Var2	Var3	Var4
	Access	Read/ Write	Read/ Write	Read Only	Read Only
	Register	Holding (4)00001	Holding (4)00002	Input (3)00001	Input (3)00002
	Type	Word as Word	Word as Real	Word as Word	Word as Real
	Format	Hexa-decimal	Soft Sign 2 digits after DP	Hexa-decimal	Soft Sign 2 digits after DP
AC30	Process Data	0627 Comms Control WORD	0681 Comms Reference	0661 Status Word	0395 Actual Speed Percent
	Type	WORD	REAL	WORD	REAL
	Bytes	2	4	2	4

4. Configure the display.

Double-click on the **User Interface** tab.

From the drawing windows click on the **Integer Text** symbol.

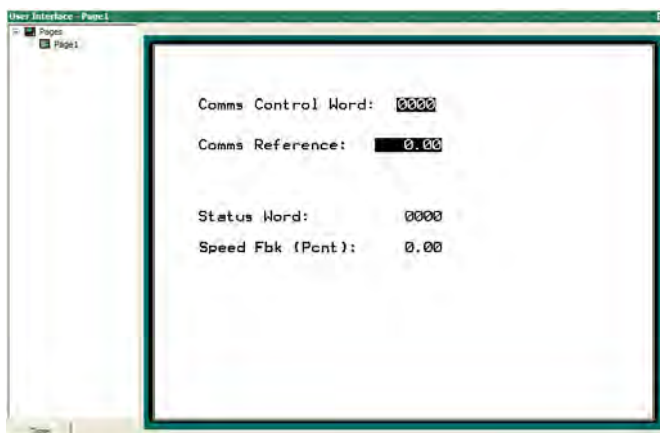

Next create the image text by click and dragging on the User Interface window. Double click on the created box to bring up a properties window.

From the **Data Source**, select **Tag** from the pull-down **Value** menu, then select **Var1**.

As Var1 is a writable parameter select **Yes** for **Data Entry**.

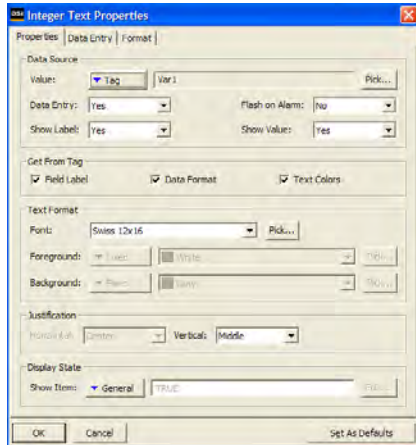

Repeat for Var2, Var3 and Var4. As Var2 and Var4 are Real types then choose the **Real Text** symbol from the Drawing menu.



When the User Interface has been configured click on Close.

5. Update the TS8000 with the Configuration.

First select from the main menu **Link** and **Options**. Choose the programming port you are using to connect the TS8000 to the PC.

Next select **Link** followed by **Update...** to load the configuration.

Configuring the AC30

AC30 Parker Drive Quicktool (PDQ)

When performing an online configuration, the fitted option card will automatically be selected. In offline mode, parameter **0044 Comms required** must be set to **MODBUS RTU**:

Create a New Drive - Drive

 Choose a Task Drive Application Motor Motor Control Input/Output

Power Stack	4.5A 400V
? Comms Required	ETHERNET IP
Range :	NONE
Type of communication option required by application	BACNET IP
IO Option Type	BACNET MSTP
Drive Name	CANOPEN
	CC LINK
	CONTROLNET
	DEVICENET
	ETHERCAT
	ETHERNET IP
	MODBUS RTU
	MODBUS TCP
	PROFIBUS DPV1
	PROFINET IO

Set the **0232 High Word First RTU**, **0229 Device Address**, **0230 Modbus RTU Baud Rate**, **0231 Parity and Stop Bits** and **0233 Modbus RTU Timeout** parameters to the required values:

(44) Comms Required	MODBUS RTU
(229) Modbus Device Address	5
(230) Modbus RTU Baud Rate	115200 BPS
(231) Parity And Stop Bits	EVEN, 1 STOP
(232) High Word First RTU	True
? Modbus RTU Timeout	1s
Range : t#0s ---> t#65s	
ID : 233	
The required Modbus RTU process active timeout.	
(48) Comms Trip Enable	True

Add the required parameters to the Read Process Mapping table (parameter **0055 Read Mapping**) by selecting them from the popup window:

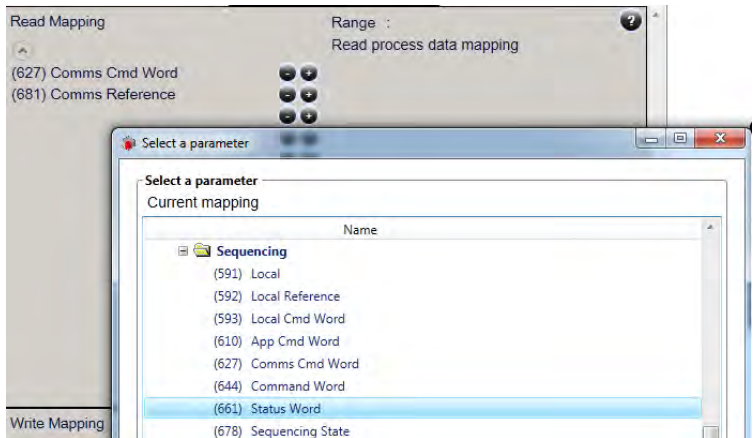

Add the required parameters to the Write Process Mapping table (parameter **0120 Write Mapping**) by selecting them from the popup window:

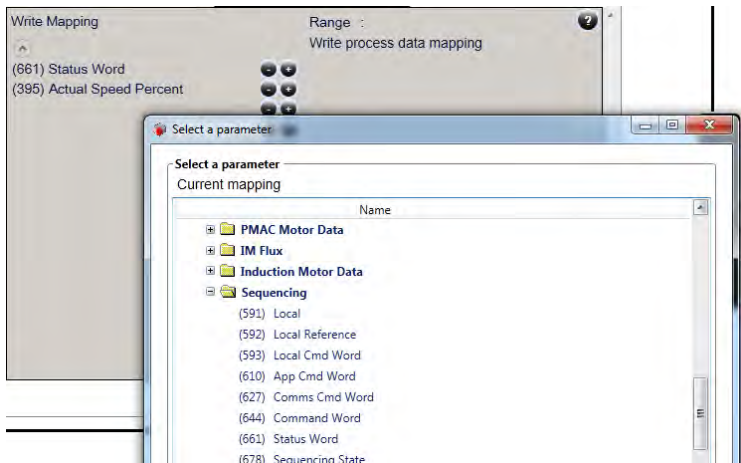

Note the Process Data mapping ends on the first empty entry.

Acyclic Data Exchange

AC30 parameters may be accessed acyclically across the network.

Overview

The AC30 parameters are mapped to **Holding Registers** starting at register address 0529.

Each parameter number is mapped on to two registers regardless of the parameter data type.

If the parameter has a data type that uses one byte then it will occupy the low-byte of the first register. If the parameter has a data type that uses two bytes then it will occupy the first register. Unused register locations will read zero; writing to that location will have no effect.

The word-order of 32-bit parameters is determined by the **0232 High Word First RTU** parameter.

The data size of the AC30 parameter types is given in [Appendix C – Data Types](#).

The relationship between an AC30 parameter and a Holding Register is given as:

$$\text{Register number} = (\text{parameter number} - 1) * 2 + 0529$$

Arrays

Access to AC30 parameter arrays is achieved through individual element parameter numbers, as described in [Appendix A – Array Parameter Numbers](#).

It is not recommended to access the array through the parameter number that represents the whole array. This will only access the first four bytes of the array.

Strings

String parameters have a parameter number that represents the whole string. This parameter number is mapped to two registers so limits access to the first four characters. Additional contiguous parameter numbers are set aside so that the whole string can be accessed: one additional parameter number for each four characters. Characters are packed low-to-high in the registers. This is described in [Appendix B – String Parameter Numbers](#).

Example Acyclic String Access

Using the TS8000 HMI has been described in the Example Configuration section, and will be extended here to include acyclic string access.

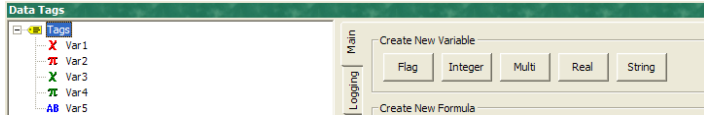

Click on the **Data Tags** tab and click on **String** under **Create New Variable** in this case **Var5**.

The Var5 tag will be mapped to the **0961 Drive Name** parameter. This is a string of size **23** characters. The parameter number that represents the start of the *complete* string will be **0962**. This equates to a Modbus register number of **02451**.

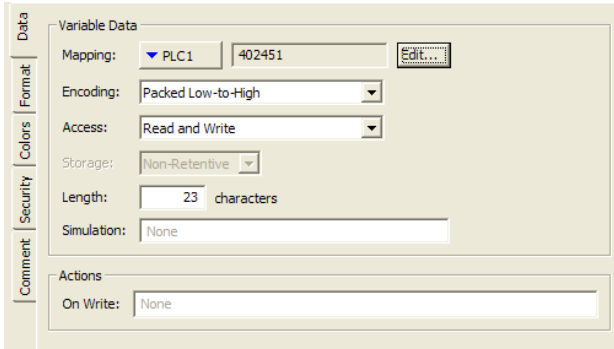

Click on the **Var5** tag and select **Mapping** to **PLC1**. Click on **Edit...** and in the popup window set:

Data Item to **Holding Registers**

Element to **02451**

Data Type to **Word as Word**

Also set:

Encoding to **Packed Low-to-High**

Access to **Read and Write**.

Length to **23**

Under the **Format** tag set the **Field Width** to **23**.

Configure the display as described in Part 6 of the Example Using TS8000 HMI, except a string parameter is to be added. For that click on the **String Text** symbol in the **Drawing** window.

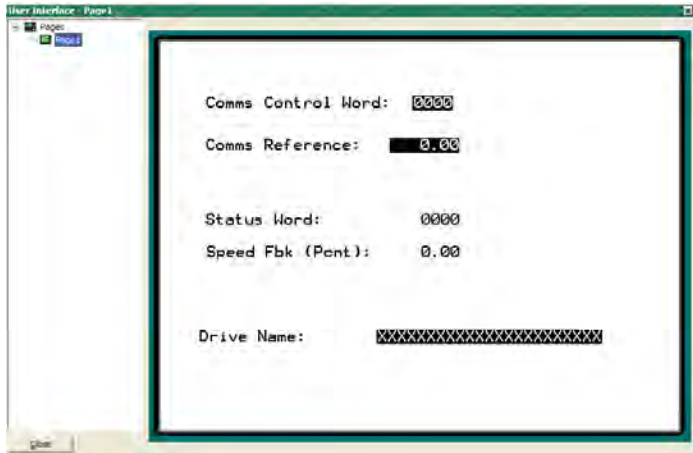

Lost Communications Trip

Supervised Parameter

The parameter **0047 Comms Supervised** indicates that the Modbus network participation is supervised by another Modbus device.

The Supervised parameter value is set to TRUE when the option is in the PROCESS ACTIVE or IDLE state *and* the parameter **0233 Modbus RTU Timeout** is set a value other than zero.

The Supervised parameter will subsequently change to FALSE if the module changes from the PROCESS ACTIVE or IDLE state.

Comms Break Trip

The Comms Break trip will generate a trip if a break in communications is detected. A trip event will be generated when a transition from TRUE to FALSE of the parameter **0047 Comms Supervised** occurs.

To enable the Comms Break trip, the parameter **0048 Comms Trip Enable** must be set to TRUE *and* the **COMMS BREAK** bit set in the parameter **0697 Enable 1-32**. The parameter **0233 Modbus RTU Timeout** must be set to a value other than zero.

For more information on enabling trips see Chapter 10 Trips & Fault Finding in the AC30 Product Manual HA501718U001.

Diagnostic Event

A single diagnostic event may be created. The diagnostic is represented on the network as a dedicated entry in the Modbus Input register **00258**. The severity is fixed as Minor Recoverable.

The number of diagnostic events active can be found in the Modbus Input register **00257**. This will be either 0 or 1.

A summary of the Modbus Input registers used for the diagnostic events is given below:

Input Register	Contents	Comment
00257	Diagnostic Event Count	Number of active diagnostic events
00258	Diagnostic Event #1	High byte = Severity (Minor recoverable = 0) Low byte = Event code
00259	Diagnostic Event #2	Unsupported
00260	Diagnostic Event #3	
00261	Diagnostic Event #4	
00262	Diagnostic Event #5	
00263	Diagnostic Event #6	

Four AC30 parameters are associated with the diagnostic event:

0185 Comms Event Code

This code will be entered into the Diagnostic Event #1 Input register when the diagnostic become active.

0187 Comms Event Set

A rising edge signal from FALSE to TRUE will create a diagnostic event. The **Comms Event Clear** parameter must be set FALSE.

0188 Comms Event Clear

A rising edge signal from FALSE to TRUE will remove a diagnostic event. The **Comms Event Set** parameter must be set to FALSE.

0186 Comms Event Active

This parameter indicates if a diagnostic event is active or not.

Note: The rising edge signals for Comms Event Set and Comms Event Clear must be held for at least 10ms in FALSE and at least 10ms in TRUE to take effect.

When a diagnostic event is active the Device Status LED will double flash red.

Parameters

Configuration Parameters

0044 Comms Required		Range	RW	Saved	Config
Type	UINT (enumerated)	(1) NONE	✓	✓	✓
Default	NONE	(2) BACNET IP			
Communications option parameter. Sets the required communications option.		(3) BACNET MSTP			
		(4) CANOPEN			
		(5) CC LINK			
		(6) CONTROLNET			
		(7) DEVICENET			
		(8) ETHERCAT			
		(9) ETHERNET IP			
		(10) MODBUS RTU			
		(11) MODBUS TCP			
		(12) PROFIBUS DPV1			
		(13) PROFINET IO			

0229 Modbus Device Address		Range	RW	Saved	Config
Type	USINT	1	✓	✓	✓
Default	0	...			
Modbus RTU communications option parameter. Sets the required device address.		247			

0232 High Word First RTU		Range	RW	Saved	Config
Type	BOOL	FALSE TRUE	✓	✓	✓
Default	FALSE				
Modbus RTU communications option parameter. If set to TRUE, the most significant word of a 32-bit parameters will be mapped to the first register, and the least significant word to the next register.					

0230 Modbus RTU Baud Rate		Range	RW	Saved	Config
Type	USINT (enumerated)	(0) 1200 BPS	✓	✓	✓
Default	19200 BPS	(1) 2400 BPS			
Modbus RTU communications option parameter. Sets the Baud rate of the option.		(2) 4800 BPS (3) 9600 BPS (4) 19200 BPS (5) 38400 BPS (6) 57600 BPS (7) 76800 BPS (8) 115200 BPS			

0231 Parity And Stop Bits		Range	RW	Saved	Config
Type	USINT (enumerated)	(0) EVEN, 1 STOP	✓	✓	✓
Default	EVEN, 1 STOP	(1) ODD, 1 STOP			
Modbus RTU communications option parameter. Sets the parity and stop bits of the option.		(2) NONE, 2 STOP (3) NONE, 1 STOP			

0233 Modbus RTU Timeout		Range	RW	Saved	Config
Type	TIME	0 ... 65.0 seconds	✓	✓	✓
Default	3.0 seconds				
Modbus RTU communications option parameter. Sets the process active timeout of the option. A value of zero disables the timeout.					

0055 Read Mapping		Range	RW	Saved	Config
Type	Array of UINT	0 ... Last parameter number	✓	✓	✓
Default	-				
Communications option parameter. Sets the required read process data mapping. Each entry in the table represents the required parameter number.					

0120 Write Mapping		Range	RW	Saved	Config
Type	Array of UINT	0 ... Last parameter number	✓	✓	✓
Default	-				
Communications option parameter. Sets the required write process data mapping. Each entry in the table represents the required parameter number.					

0048 Comms Trip Enable		Range	RW	Saved	Config
Type	BOOL	FALSE	✓	✓	×
Default	TRUE	TRUE			
Communications option parameter. Enables the communications trip.					

Runtime Parameters

0185 Comms Event Code		Range	RW	Saved	Config
Type	BYTE	0x00	✓	×	×
Default	0	...			
Communications option parameter. Sets the event code to be used when a diagnostic event is created.		0xFF			

0187 Comms Event Set		Range	RW	Saved	Config
Type	BOOL	FALSE	✓	×	×
Default	FALSE	TRUE			
Communications option parameter. A rising edge (FALSE to TRUE) will create a diagnostic event.					

0188 Comms Event Clear		Range	RW	Saved	Config
Type	BOOL	FALSE	✓	×	×
Default	FALSE	TRUE			
Communications option parameter. A rising edge (FALSE to TRUE) will remove a diagnostic event.					

Diagnostic Parameters

0045 Comms Fitted		Range
Type	USINT (enumerated)	(0) UNKNOWN
		(1) NONE
		(2) BACNET IP
		(3) BACNET MSTP
		(4) CANOPEN
		(5) CC LINK
		(6) CONTROLNET
		(7) DEVICENET
		(8) ETHERCAT
		(9) ETHERNET IP
		(10) MODBUS RTU
		(11) MODBUS TCP
		(12) PROFIBUS DPV1
		(13) PROFINET IO
Communications option parameter. Indicates the communications option fitted.		

0046 Comms State		Range
Type	USINT (enumerated)	
Communications option parameter.		
Indicates the state of the communications option fitted.		<ul style="list-style-type: none"> (0) SETUP – setup in progress (1) NW INIT – network-related initialisation tasks are being performed (2) WAIT PROCESS – awaiting Modbus request (3) IDLE – this state is entered when the Holding Register 00517 has a value other than 0 (4) PROCESS ACTIVE – a Modbus request addressed to this node has been received within the last Process Active Timeout period, or, if no timeout is specified, the module will stay in this state after the first received Modbus request. (5) ERROR – network error (6) RESERVED (7) EXCEPTION – unrecoverable error (8) NONE – option not fitted

0228 Modbus RTU State		Range
Type	USINT (enumerated)	
		(0) SETUP – setup in progress
		(1) NW INIT – network-related initialisation tasks are being performed
		(2) WAIT PROCESS – awaiting Modbus request
		(3) IDLE – this state is entered when the Holding Register 00517 has a value other than 0
		(4) PROCESS ACTIVE – a Modbus request addressed to this node has been received within the last Process Active Timeout period, or, if no timeout is specified, the module will stay in this state after the first received Modbus request.
		(5) ERROR – network error
		(6) RESERVED
		(7) EXCEPTION – unrecoverable error
		(8) NONE – option not fitted
<p>Modbus RTU communications option parameter.</p> <p>Indicates the state of the communications option fitted as the parameter 0046 Comms State, but specifically for Modbus RTU.</p>		

0047 Comms Supervised		Range
Type	BOOL	
		FALSE
		TRUE
<p>Communications option parameter.</p> <p>Indicates that the Modbus network participation is supervised by another Modbus device. The Process Active Timeout must be set to a value other than 0.</p>		

0049 Comms Module Version		Range
Type	DWORD	0x00000000
Communications option parameter.		...
Firmware version of the option communications module.		0xFFFFFFFF
		The most significant byte is the major version number, followed by the minor version number. The least significant byte is the build number.

0050 Comms Module Serial		Range
Type	DWORD	0x00000000
Communications option parameter.		...
Serial number of the option communications module.		0xFFFFFFFF

0051 Comms Diagnostic		Range
Type	USINT (enumerated)	(0) NONE
Communications option parameter.		(1) HARDWARE MISMATCH – required communications option does not match that fitted, or no option fitted but one is required.
Indicates the state of the communications option fitted.		(2) INVALID CONFIGURATION – the configuration of the option is not valid.
		(3) MAPPING FAILED – the process data mapping is not permitted, e.g. adding read-only parameters to the read process data mapping.
		(4) EXCEPTION – configuration error.
		(5) UNSUPPORTED OPTION – the fitted option is not currently supported.

0052 Comms Diagnostic Code		Range
Type	DWORD	0x00000000 ... 0xFFFFFFFF
Communications option parameter. Diagnostic code associated with the Diagnostic parameter.		

0053 Comms Exception		Range
Type	BYTE	0x00 ... 0xFF
Communications option parameter. Exception code associated with the Diagnostic parameter being in EXCEPTION		

0054 Comms Net Exception		Range
Type	BYTE	0x00 ... 0xFF
Communications option parameter. Network specific exception code associated with the Diagnostic parameter being in EXCEPTION		

0186 Comms Event Active		Range
Type	BOOL	FALSE TRUE
Communications option parameter. Indicates a diagnostic event is active.		

Troubleshooting

Configuration problems can often be identified by looking at the Communication and Device Status LEDs and from the Modbus RTU State and Comms Diagnostic parameters. Under normal operating conditions the Comms Diagnostic parameter should indicate NONE. Other values are summarized in the Diagnostic Parameters section.

Hardware Mismatch

Comms Diagnostic = HARDWARE MISMATCH

- The required option does not match the actual fitted option.
- No option is fitted but one is required.

Invalid Configuration

Comms Diagnostic = INVALID CONFIGURATION

- Invalid read or write process data mapping.
- Invalid communication settings.

Comms Diagnostic = MAPPING FAILED

- Attempting to map a parameter that does not exist.
- Attempting to map a configuration parameter.
- Attempting to map a string parameter.
- Attempting to map a read-only parameter to the read process data.

Device Status LED Flashing Red (single flash)

- Invalid communication settings.
- Communication settings changed during operation (Holding registers 00513 – 00515 have been modified).

Modbus Exceptions

Comms Exception Codes

- 01h - Illegal function.
- 02h – Illegal data address.
- 03h – Illegal data value.

Register Writing

Writing to a 32-bit parameter acyclically fails

- Both registers that make up a 32-bit parameter must be written together using a multiple write.

Appendix A – Array Parameter Numbers

Some parameters have multiple elements and are classified as parameter arrays. A parameter array has a parameter number that accesses the *whole* of the array. It also has parameter numbers that represent each *element* of the array.

Array Example

A parameter array called **My Array** has 4 elements.

Parameter Number	Parameter - My Array
0152	Whole array
0153	index 0
0154	index 1
0155	index 2
0156	index 3

If the parameter number of the whole array is 0152, then the parameter number of the element index 0 of the array will be 0153, the parameter number of the element index 1 will be 0154, etc.

Note that *string* array parameters access their elements via parameter numbers that are calculated in a different way.

Appendix B – String Parameter Numbers

To enable access of string parameters over Modbus, in addition to the parameter number that represents the whole string, multiple contiguous parameter numbers are allocated so that the parameter can be broken down into multiple registers.

An additional parameter number is allocated for each four-character fragment of the string.

String Example

A string parameter called **My String** has a string length of 12 characters (plus the null terminator). This will have one parameter number allocated for the whole string (in this example 0161) and 3 further parameter numbers for the string fragments (0162-0164).

If the value of the string is "0123456789AB":

Parameter Number	Represents	Register Number	Register Value	
			hi-byte	lo-byte
0161	whole string "0123456789AB"	00849	'1'	'0'
		00850	'3'	'2'
0162	fragment "0123"	00851	'1'	'0'
		00852	'3'	'2'
0163	fragment "4567"	00853	'5'	'4'
		00854	'7'	'6'
0164	fragment "89AB"	00855	'9'	'8'
		00856	'B'	'A'

As each AC30 parameter maps to two registers, if the registers that represent the whole string is accessed then only the first four characters will appear. To access the whole string over Modbus use the registers that map to the parameter number of the whole array plus one, in this example **0162** (register **00851**). A multiple read or write of registers will then provide access to the whole string.

String Array Example

A string array parameter called **My String Array** has 2 elements of string length 5 characters (plus the null terminator) each. In this example the parameter number of the whole array is 0175.

If the values of the array elements are "12345" and "abc":

Parameter Number	Represents	Register Number	Register Value	
			hi-byte	lo-byte
0175	whole array ["12345", "abc"]	00877	'2'	'1'
		00878	'4'	'3'
0176	1 st element "12345"	00879	'2'	'1'
		00880	'4'	'3'
0177	fragment "1234"	00881	'2'	'1'
		00882	'4'	'3'
0178	fragment "5"	00883	<i>null</i>	'5'
		00884	?	?
0179	2 nd element "abc"	00885	'b'	'a'
		00886	<i>null</i>	'c'
0180	fragment "abc"	00887	'b'	'a'
		00888	<i>null</i>	'c'
0181	fragment ""	00889	?	?
		00890	?	?

To access the first element of the array over Modbus then parameter number **0177** (register **00881**) would be used. To access the second element then parameter number **0180** (register **00887**) would be used.

Appendix C – Data Types

The AC30 parameter data type and size and number of registers used for process data mapping are given in the below.

Note for acyclic access all parameters map to two registers regardless of data type.

AC30 Parameter			Process Data
Data Type	Description	Bytes	No of registers
BOOL	Boolean	1	1
SINT	Short integer	1	1
INT	Integer	2	1
DINT	Double integer	4	2
USINT	Unsigned short integer	1	1
UINT	Unsigned integer	2	1
UDINT	Unsigned double integer	4	2
REAL	Floating point	4	2
TIME	Duration	4	2
DATE	Date	4	2
TIME_OF_DAY	Time of day	4	2
DATE_AND_TIME	Date and time of day	4	2
STRING	String	<i>n</i>	<i>not permitted</i>
BYTE	Bit string length 8	1	1
WORD	Bit string length 16	2	1
DWORD	Bit string length 32	4	2

Parker Worldwide

AE – UAE, Dubai
Tel: +971 4 8127100
parker.me@parker.com

AR – Argentina, Buenos Aires
Tel: +54 3327 44 4129

AT – Austria, Wiener Neustadt
Tel: +43 (0)2622 23501-0
parker.austria@parker.com

AT – Eastern Europe, Wiener Neustadt
Tel: +43 (0)2622 23501 900
parker.eastereurope@parker.com

AU – Australia, Castle Hill
Tel: +61 (0)2-9634 7777

AZ – Azerbaijan, Baku
Tel: +994 50 2233 458
parker.azerbaijan@parker.com

BE/LU – Belgium, Nivelles
Tel: +32 (0)67 280 900
parker.belgium@parker.com

BR – Brazil, Cachoeirinha RS
Tel: +55 51 3470 9144

BY – Belarus, Minsk
Tel: +375 17 209 9399
parker.belarus@parker.com

CA – Canada, Milton, Ontario
Tel: +1 905 693 3000

CH – Switzerland, Etoy
Tel: +41 (0)21 821 87 00
parker.switzerland@parker.com

CL – Chile, Santiago
Tel: +56 2 623 1216

CN – China, Shanghai
Tel: +86 21 2899 5000

CZ – Czech Republic, Klecany
Tel: +420 284 083 111
parker.czechrepublic@parker.com

DE – Germany, Kaarst
Tel: +49 (0)2131 4016 0
parker.germany@parker.com

DK – Denmark, Ballerup
Tel: +45 43 56 04 00
parker.denmark@parker.com

ES – Spain, Madrid
Tel: +34 902 330 001
parker.spain@parker.com

FI – Finland, Vantaa
Tel: +358 (0)20 753 2500
parker.finland@parker.com

FR – France, Contamine s/Arve
Tel: +33 (0)4 50 25 80 25
parker.france@parker.com

GR – Greece, Athens
Tel: +30 210 933 6450
parker.greece@parker.com

HK – Hong Kong
Tel: +852 2428 8008

HU – Hungary, Budapest
Tel: +36 1 220 4155
parker.hungary@parker.com

IE – Ireland, Dublin
Tel: +353 (0)1 466 6370
parker.ireland@parker.com

IN – India, Mumbai
Tel: +91 22 6513 7081-85

IT – Italy, Corsico (MI)
Tel: +39 02 45 19 21
parker.italy@parker.com

JP – Japan, Tokyo
Tel: +81 (0)3 6408 3901

KR – South Korea, Seoul
Tel: +82 2 559 0400

KZ – Kazakhstan, Almaty
Tel: +7 7272 505 800
parker.eastereurope@parker.com

MX – Mexico, Apodaca
Tel: +52 81 8156 6000

MY – Malaysia, Shah Alam
Tel: +60 3 7849 0800

NL – The Netherlands, Oldenzaal
Tel: +31 (0)541 585 000
parker.nl@parker.com

NO – Norway, Asker
Tel: +47 66 75 34 00
parker.norway@parker.com

NZ – New Zealand, Mt Wellington
Tel: +64 9 574 1744

PL – Poland, Warsaw
Tel: +48 (0)22 573 24 00
parker.poland@parker.com

PT – Portugal, Leca da Palmeira
Tel: +351 22 999 7360
parker.portugal@parker.com

RO – Romania, Bucharest
Tel: +40 21 252 1382
parker.romania@parker.com

RU – Russia, Moscow
Tel: +7 495 645-2156
parker.russia@parker.com

SE – Sweden, Spånga
Tel: +46 (0)8 59 79 50 00
parker.sweden@parker.com

SG – Singapore
Tel: +65 6887 6300

SK – Slovakia, Banská Bystrica
Tel: +421 484 162 252
parker.slovakia@parker.com

SL – Slovenia, Novo Mesto
Tel: +386 7 337 6650
parker.slovenia@parker.com

TH – Thailand, Bangkok
Tel: +662 717 8140

TR – Turkey, Istanbul
Tel: +90 216 4997081
parker.turkey@parker.com

TW – Taiwan, Taipei
Tel: +886 2 2298 8987

UA – Ukraine, Kiev
Tel: +380 44 494 2731
parker.ukraine@parker.com

UK – United Kingdom, Warwick
Tel: +44 (0)1926 317 878
parker.uk@parker.com

US – USA, Cleveland
Tel: +1 216 896 3000

VE – Venezuela, Caracas
Tel: +58 212 238 5422

ZA – South Africa, Kempton Park
Tel: +27 (0)11 961 0700
parker.southafrica@parker.com

European Product Information Centre

Free phone: 00 800 27 27 5374

(from AT, BE, CH, CZ, DE, EE, ES, FI, FR, IE, IL, IS, IT, LU, MT, NL, NO, PT, SE, SK, UK)

© 2012 Parker Hannifin Corporation. All rights reserved.

**Parker Hannifin Manufacturing Limited, Automation Group,
Electromechanical Drives Business Unit,**

New Courtwick Lane, Littlehampton,

West Sussex BN17 7RZ

United Kingdom

Tel: +44(0)1903 737000

Fax: +44(0)1903 737100

www.parker.com/ssd



* H A 5 0 1 8 3 9 0 0 1 0 4 *